

NOTES:

1. DIMENSIONS ARE IN INCHES [mm].
2. ENCLOSURE SHOWN WITH OPTIONAL HOLES FOR LIGHT / HORN AND BUTTON.
3. ENCLOSURES PURCHASED WITHOUT THE OPTIONAL LIGHT / HORN AND/OR BUTTON ARE NOT DRILLED AT THOSE LOCATIONS.

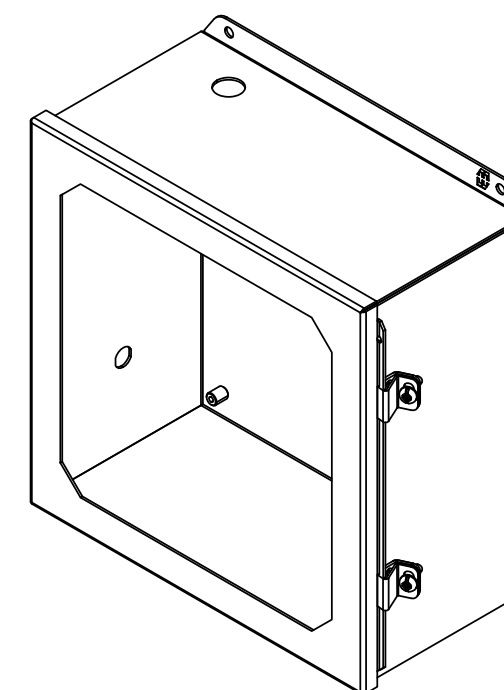
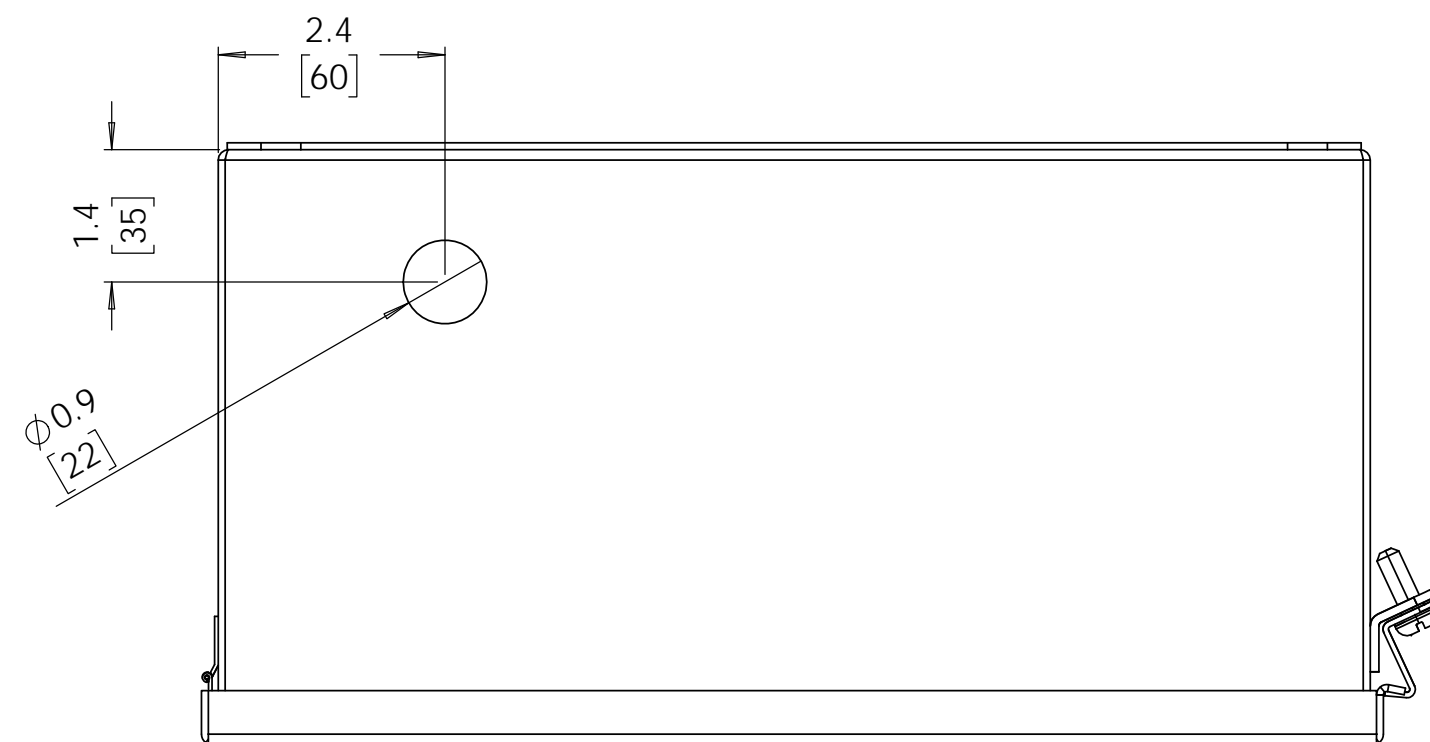

PRECISION DIGITAL CORPORATION
HOPKINTON, MASSACHUSETTS 01748

PDA2909
CONSOLIDATOR+ ENCLOSURE
WITH OPTIONAL CUTOUTS FOR
LIGHT / HORN AND BUTTON